

DOMESTIC TRACKS

WARDROBE-RODS AND
SHOWER-RODS

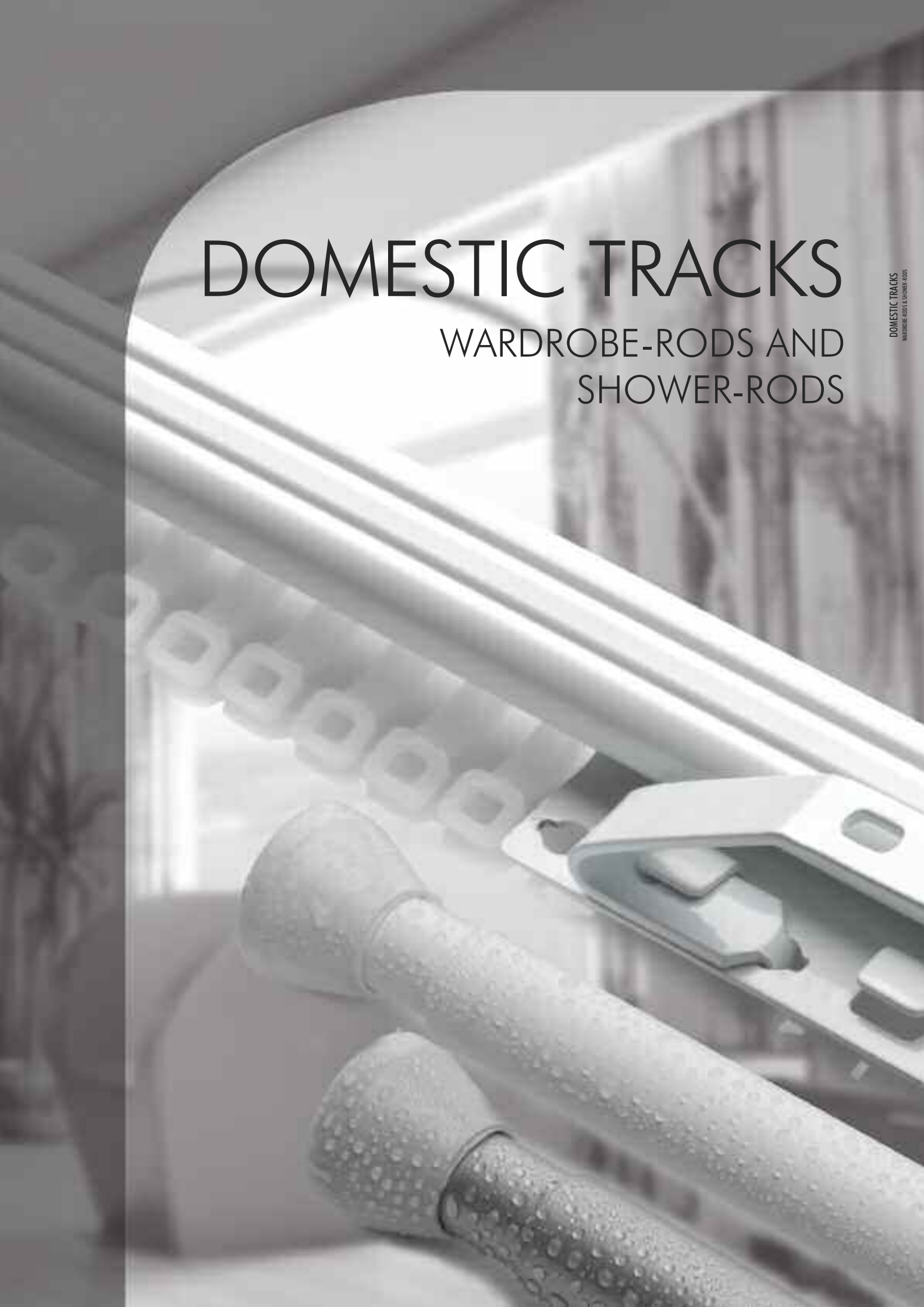

« EXTENDIBLE STEEL CORDED TRACKS »

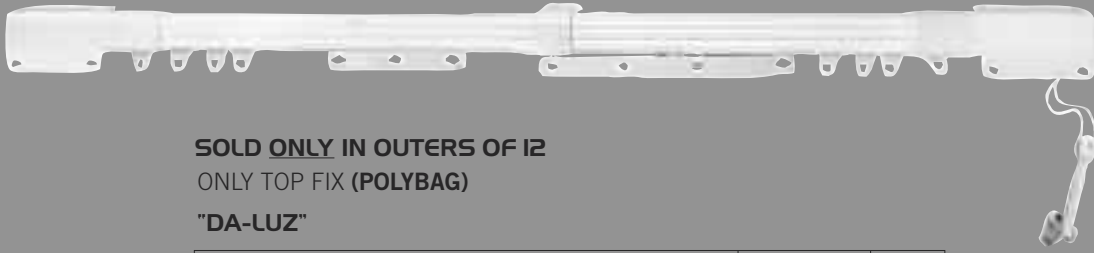

SOLD ONLY IN OUTERS OF 12
ONLY TOP FIX (POLYBAG)

"DA-LUZ"

METRE / INCH	REFERENCE	OUTER
N°1: 0.74 - 1.24 m. / 29" - 49" (1 CNTL. BKT./OUTER)	3021064	12
N°2: 1.22 - 2.13 m. / 48" - 84" (2 CNTL. BKTS./1 OUTER-1 INNER)	3022064	12
N°3: 1.67 - 3.05 m. / 66" - 120" (3 CNTL. BKTS./2 OUTER-1 INNER)	3023064	12
N°4: 2.37 - 4.50 m. / 93" - 177" (4 CNTL. BKTS./2 OUTER-2 INNER)	3024064	12



KITS SOLD INDIVIDUALLY
FACE/TOP FIX (POLYBAG)

"DA-LUZ"

METRE / INCH	REFERENCE	OUTER
N°1: 0.74 - 1.24 m. / 29" - 49" (1 CNTL. BKT./OUTER)	3011064	12
N°2: 1.22 - 2.13 m. / 48" - 84" (2 CNTL. BKTS./1 OUTER-1 INNER)	3012064	12
N°3: 1.67 - 3.05 m. / 66" - 120" (3 CNTL. BKTS./2 OUTER-1 INNER)	3013064	12
N°4: 2.37 - 4.50 m. / 93" - 177" (4 CNTL. BKTS./2 OUTER-2 INNER)	3014064	12
N°5: 3.25 - 6.00 m. / 128" - 236" (5 CNTL. BKTS./3 OUTER-2 INNER)	3015064	12

KITS SOLD INDIVIDUALLY
FACE/TOP FIX (BLISTER PACK)

"DA-LUZ"

METRE / INCH	REFERENCE	OUTER
N°1: 0.74 - 1.24 m. / 29" - 49" (1 CNTL. BKT./OUTER)	3011062	12
N°2: 1.22 - 2.13 m. / 48" - 84" (2 CNTL. BKTS./1 OUTER-1 INNER)	3012062	12
N°3: 1.67 - 3.05 m. / 66" - 120" (3 CNTL. BKTS./2 OUTER-1 INNER)	3013062	12
N°4: 2.37 - 4.50 m. / 93" - 177" (4 CNTL. BKTS./2 OUTER-2 INNER)	3014062	12

« VALANCE RAIL WITH EXTENDIBLE TRACK »

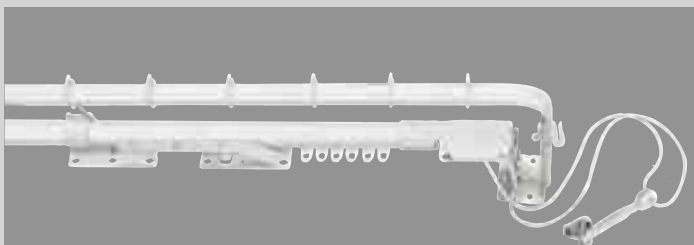

SOLD INDIVIDUALLY

METRE / INCH	REFERENCE	OUTER
N°1: 0.74 - 1.24 m. / 29" - 49" (1 CNTL. BKT./OUTER)	3016062	4
N°2: 1.22 - 2.13 m. / 48" - 84" (2 CNTL. BKTS./1 OUTER-1 INNER)	3017062	4
N°3: 1.67 - 3.05 m. / 66" - 120" (3 CNTL. BKTS./2 OUTER-1 INNER)	3018062	4
N°4: 2.18 - 3.81 m. / 86" - 150" (3 CNTL. BKTS./2 OUTER-1 INNER)	3019062	4

« EXTENDIBLE METAL VALANCE »

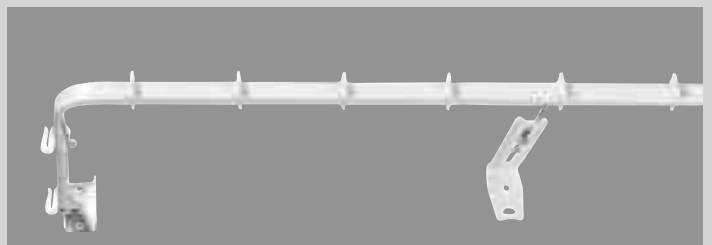

SOLD INDIVIDUALLY

METRE / INCH	REFERENCE	OUTER
N°1: 0.74 - 1.24 m. / 29" - 49" (1 CNTL. BKT.)	1881065	6
N°2: 1.22 - 2.13 m. / 48" - 84" (1 CNTL. BKT.)	1882065	6
N°3: 1.67 - 3.05 m. / 66" - 120" (2 CNTL. BKTS.)	1883065	6
N°4: 2.18 - 3.81 m. / 86" - 150" (2 CNTL. BKTS.)	1885065	6

COLOUR CODE: 06. WHITE

PACKAGING CODE: 2. BLISTER 4. PLASTIC BAG 5. PLASTIC BAG WITH TAG

« STEEL TRACK AND ACCESSORIES »

<p>STEEL TRACK (4m.)</p>  <p>0119060 (10 un.) 0119063 (10 un.)</p>	<p>FILLERS</p>  <p>1869060 (1 un.)</p>	<p>FORMER</p>  <p>1879060 (1 un.)</p>	<p>SPACER</p>  <p>19</p> <p>1886060 (100 un.)</p>	<p>SCISSORS</p>  <p>0140400 (1 un.)</p>	<p>SILICON 500 ml.</p>  <p>1888060 (1 un.)</p>	<p>CORD 2.8/3.0mm.</p>  <p>0096060 (200 m.)</p>
<p>END PULLEY</p>  <p>90</p> <p>1235060 (25 pairs)</p>	<p>END PULLEY FLIP-OVER BACK</p>  <p>90</p> <p>1896060 (25 pairs)</p>	<p>END-STOP</p>  <p>30</p> <p>0017060 (50 un.)</p>	<p>STRAIGHT MASTER</p>  <p>150</p> <p>1223060 (25 pairs)</p>	<p>CURVED MASTER</p>  <p>150</p> <p>1232060 (25 pairs)</p>	<p>DA-LUZ SLIDE</p>  <p>28</p> <p>1200060 (500 un.)</p>	<p>CHYC SLIDE</p>  <p>31</p> <p>0080060 (500 un.)</p>
<p>STIRR-UP (50 un.)</p>  <p>34</p> <p>0028060 (INNER) 0085060 (OUTER)</p>	<p>BKT. 3-6 cm. (50 un.)</p>  <p>60 max.</p> <p>0025060 (INNER) 0122060 (OUTER)</p>	<p>BKT. 6-9 cm. (50 un.)</p>  <p>82 max.</p> <p>0651060 (INNER) 0084060 (OUTER)</p>	<p>BKT. 6-9 cm. (50 un.)</p>  <p>82 max.</p> <p>0059060 (INNER) 0058060 (OUTER)</p>	<p>PLAIN BKT. 6-9 cm.</p>  <p>0012060 (50 un.)</p>	<p>BKT. 9-12 cm.</p>  <p>125</p> <p>1817060 (20 un.)</p>	<p>BKT. 20 cm.</p>  <p>200</p> <p>1229060 (25 un.)</p>
<p>END-BKT. 3-6 cm.</p>  <p>60 max.</p> <p>0124060 (25 pairs)</p>	<p>END-BKT. 6-9 cm.</p>  <p>82 max.</p> <p>0125060 (25 pairs)</p>	<p>END-BKT. 6-9 cm.</p>  <p>82 max.</p> <p>0075060 (25 pairs)</p>	<p>END-BKT. 9-12 cm.</p>  <p>145</p> <p>0126060 (25 pairs)</p>	<p>RECESS BKT.</p>  <p>45</p> <p>0127060 (50 un.)</p>	<p>SPLICE</p>  <p>166</p> <p>0132400 (50 un.)</p>	<p>EXT. PLAQUE</p>  <p>138</p> <p>0083060 (50 un.)</p>
<p>INSERT PULLEY</p>  <p>6,2</p> <p>0133400 (50 un.)</p>	<p>SINGLE END-PULLEY</p>  <p>20</p> <p>1894060 (50 un.)</p>	<p>VINE-EYE</p>  <p>65</p> <p>1564440 (100 un.)</p>	<p>TENSION-PULLEY</p>  <p>160</p> <p>0419060 (25 un.)</p>	<p>CORD-WEIGHT 125 gr.</p>  <p>106</p> <p>1224060 (10 un.)</p>	<p>CORD-WEIGHT 50 gr.</p>  <p>62</p> <p>1237060 (25 un.)</p>	<p>BELL CORD-WEIGHT</p>  <p>64</p> <p>0400060 (25 un.)</p>
<p>"T" BKT.</p>  <p>80</p> <p>1895060 (W) (20 un.) 1895400 (S) (20 un.)</p>	<p>"L" BKT. 10 cm.</p>  <p>70 105</p> <p>7199060 (50 un.)</p>	<p>"L" BKT. 15 cm. "S"</p>  <p>70 150</p> <p>7229060 (50 un.)</p>	<p>"L" BKT. 15 cm. "L"</p>  <p>100 150</p> <p>7226060 (25 un.)</p>	<p>"L" BKT. 19 cm.</p>  <p>100 195</p> <p>7230060 (25 un.)</p>	<p>"L" BKT. 24 cm.</p>  <p>100 240</p> <p>7231060 (25 un.)</p>	<p>NOTCHER</p>  <p>1880070 (1 un.)</p>
<p>SELF-BLOCKING NUT M4</p>  <p>0785400 (200 un.)</p>	<p>SQUARE NUT M4 (200 un.)</p>  <p>0829400 (10x10) 0791400 (12x12)</p>	<p>SCREW M4 (200 un.)</p>  <p>0762400 (M4x6) 0761400 (M4x10) 0839400 (M4x12)</p>	<p>SCREW M4 (200 un.)</p>  <p>0748400 (M4x10) 0747400 (M4x12) 0746400 (M4x14)</p>	<p>SCREW (200 un.)</p>  <p>0138400 (Ø4x30) 0139400 (Ø4x35)</p>	<p>SCREW-CAP</p>  <p>0735060 (100 un.)</p>	<p>PLUG (100 un.)</p>  <p>A</p> <p>0134320 (Ø5. A=25) 0135320 (Ø6. A=30) 0136320 (Ø8. A=40)</p>
<p>TOP-FIX END-PULLEY</p>  <p>36</p> <p>1212060 (25 pairs)</p>	<p>TOP-FIX MASTER</p>  <p>120</p> <p>1867060 (25 pairs)</p>	<p>TOP-FIX SLIDE</p>  <p>17</p> <p>0128060 (500 un.)</p>	<p>TOP-FIX STIRR-UP (50 un.)</p>  <p>33 (INNER) 36 (OUTER)</p> <p>1228060 (INNER) 1227060 (OUTER)</p>	<p>FRONT-CEILING BKT. (50 un.)</p>  <p>85</p> <p>60 max.</p> <p>0023060 (INNER) 0087060 (OUTER)</p>	<p>VALANCE RING</p>  <p>25</p> <p>1893060 (500 un.)</p>	<p>VALANCE BKT.</p>  <p>1887060 (50 un.)</p>

COLOUR CODE: 06. WHITE 32. GREY 40. SILVER 44. BRASS

PACKAGING CODE: 0. BULK

« CHYC ALUMINIUM TRACKS PROFILE 910 »

CORDED

UNCORDED

(FACE/TOP FIX) SOLD INDIVIDUALLY

METRE / INCH	REFERENCE POLYBAG	OUTER	REFERENCE BLISTER	OUTER
1.00 m. / 39" (2 BKTS.)	1960064	10	-	-
1.50 m. / 59" (3 BKTS.)	0972064	10	0972062	6
2.00 m. / 79" (3 BKTS.)	0973064	10	0973062	6
2.50 m. / 98" (4 BKTS.)	0974064	10	0974062	6
3.00 m. / 118" (4 BKTS.)	0975064	10	0975062	6
3.50 m. / 138" (4 BKTS.)	0976064	10	0976062	6
4.00 m. / 157" (5 BKTS.)	0979064	10	-	-

(FACE/TOP FIX) SOLD INDIVIDUALLY

METRE / INCH	REFERENCE POLYBAG	OUTER
1.00 m. / 39" (2 BKTS.)	2225064	10
1.50 m. / 59" (3 BKTS.)	1926064	10
2.00 m. / 79" (3 BKTS.)	1927064	10
2.50 m. / 98" (4 BKTS.)	1928064	10
3.00 m. / 118" (4 BKTS.)	1929064	10
3.50 m. / 138" (4 BKTS.)	1930064	10
4.00 m. / 157" (5 BKTS.)	2226064	10

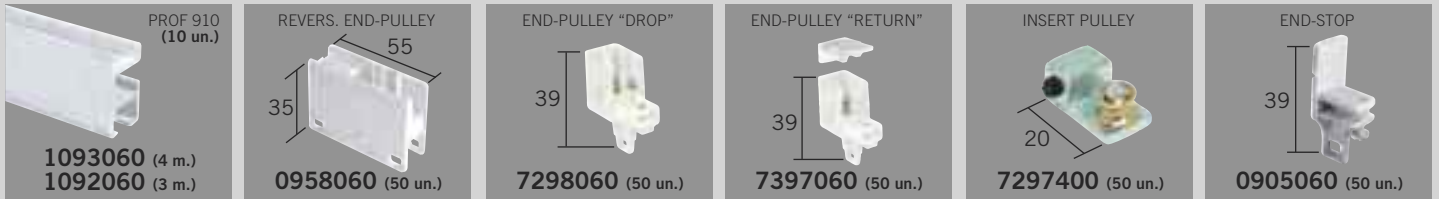

COLOUR CODE: 06. WHITE 40. SILVER 44. BRASS

PACKAGING CODE: 0. BULK 2. BLISTER 4. PLASTIC BAG

« CHYC ALUMINIUM TRACKS PROFILE 950 »

CORDED



(FACE/TOP FIX) SOLD INDIVIDUALLY

METRE / INCH	REFERENCE POLYBAG	OUTER	REFERENCE BLISTER	OUTER
1.00 m. / 39" (2 BKTS.)	1958064	10	-	-
1.50 m. / 59" (3 BKTS.)	0977064	10	0977062	6
2.00 m. / 79" (3 BKTS.)	0978064	10	0978062	6
2.50 m. / 98" (4 BKTS.)	0954064	10	0954062	6
3.00 m. / 118" (4 BKTS.)	0964064	10	0964062	6
3.50 m. / 138" (4 BKTS.)	0965064	10	0965062	6
4.00 m. / 157" (5 BKTS.)	0981064	10	-	-

UNCORDED

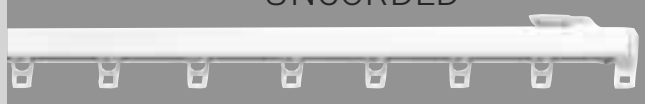

(ONLY TOP-FIX) SOLD INDIVIDUALLY

METRE / INCH	REFERENCE POLYBAG	OUTER	REFERENCE BLISTER	OUTER
1.00 m. / 39" (2 BKTS.)	1959064	20	-	-
1.50 m. / 59" (3 BKTS.)	0967064	20	0967062	6
2.00 m. / 79" (3 BKTS.)	0968064	20	0968062	6
2.50 m. / 98" (4 BKTS.)	0969064	20	0969062	6
3.00 m. / 118" (4 BKTS.)	0970064	20	0970062	6
3.50 m. / 138" (4 BKTS.)	0971064	20	-	-
4.00 m. / 157" (5 BKTS.)	0997064	20	-	-

PROF 950 (10 un.)

1096060 (4 m.)
1095060 (3 m.)

END-STOP

0905060 (50 un.)

PROF. 950 DECO (10 un.)

0644060 (4 m.)

END-STOP & END-CAP DECO

7650060 (10 pairs)

INSERT PULLEY

1230400 (50 un.)

MASTER NO ARM

0953060 (50 un.)

PLAIN MASTER NO ARM

0962060 (50 un.)

"L" OVERLAP ARM

0181060 (25 un.)

STRAIGHT ARM

0257060 (25 un.)

STRIP OF RUNNERS

1072060 (40x10 un.)

STRIP OF RUNNERS WITH WHEELS

0689060 (40x10 un.)

SHOWER SLIDE

1201060 (500 un.)

BKT. 3cm

0901060 (50 un.)

REINF. BKT. 3cm

0818060 (50 un.)

BKT. 6cm

0902060 (50 un.)

REINF. BKT. 6cm

0819060 (50 un.)

DBL. BKT. 3-9cm

0903060 (50 un.)

REINF. DBL. BKT. 3-9cm

0960060 (50 un.)

"T" BKT.

1895060 (W) (20 un.)
1895400 (S) (20 un.)

"L" BKT. 10cm.

7199060 (50 un.)

"L" BKT. 15cm. "S"

7229060 (50 un.)

"L" BKT. 15cm. "L"

7226060 (25 un.)

"L" BKT. 19cm.

7230060 (25 un.)

"L" BKT. 24cm.

7231060 (25 un.)

TENSION-PULLEY

0419060 (25 un.)

CORD-WEIGHT 125gr.

1224060 (10 un.)

CORD-WEIGHT 50gr.

1237060 (25 un.)

BELL CORD-WEIGHT

0400060 (25 un.)

VINE-EYE

1564440 (100 un.)

SILICON 500 ml.

1888060 (1 un.)

TOP-FIX BKT.

0904060 (50 un.)

TOP-FIX BKT. WITH PLATE

0993060 (50 un.)

DBL. CEILING BKT.

7275060 (25 un.)

TRBL. CEILING BKT.

7276060 (25 un.)

JOINER

0956060 (50 un.)

EXT. PLAQUE

0961060 (50 un.)

CORNER ACC.

1073060 (25 un.)

REVERS. END-PULLEY

0957060 (50 un.)

CORD 2.5/2.8mm.

2556060 (200 m.)

CORNER 90°

0852060 (10 un.)

MIDDLE-STOP

0892060 (50 un.)

SPACER

1886060 (100 un.)

BENDING TOOL

0563310 (1 un.)

FILLERS P-900 P-950

0513000 (9 fillers)

COLOUR CODE: 06. WHITE 40. SILVER 44. BRASS
PACKAGING CODE: 0. BULK 2. BLISTER 4. PLASTIC BAG

« ALUMINIUM PROFILE 7247 »

ALUMINIUM TRACK P-7247 UNCORDED

(BENDABLE BY HAND. IDEAL FOR BAY WINDOWS)



SOLD INDIVIDUALLY

METRE / INCH	REFERENCE	OUTER
1.50 m. / 59" (3 BKTS.)	7219062	10
1.75 m. / 69" (4 BKTS.)	7248062	10
2.00 m. / 79" (4 BKTS.)	7220062	10

METRE / INCH	REFERENCE	OUTER
2.25 m. / 89" (5 BKTS.)	7257062	10
2.50 m. / 98" (5 BKTS.)	7221062	10
2.75 m. / 108" (6 BKTS.)	7263062	10

METRE / INCH	REFERENCE	OUTER
3.00 m./118" (6 BKTS.)	7222062	10
3.50 m./2x69" (8 BKTS./2 PCS.)	7394062	10
4.00 m./2x79" (8 BKTS./2PCS.)	7395062	10

COMBI BENDY TRACK & VALANCE P-7247 (BENDABLE BY HAND. IDEAL FOR BAY WINDOWS)



SOLD INDIVIDUALLY

METRE / INCH	REFERENCE	OUTER
1.50 m. / 59" (3 BKTS.)	7143062	6
2.00 m. / 79" (4 BKTS.)	7144062	6
2.50 m. / 98" (5 BKTS.)	7145062	6

METRE / INCH	REFERENCE	OUTER
3.00 m./118" (6 BKTS.)	7146062	6
3.50 m./2x69" (8 BKTS./2 PCS.)	7147062	6
4.00 m./2x79" (8 BKTS./2PCS.)	7148062	6

ALUMINIUM VALANCE P-7247 (BENDABLE BY HAND. IDEAL FOR BAY WINDOWS)

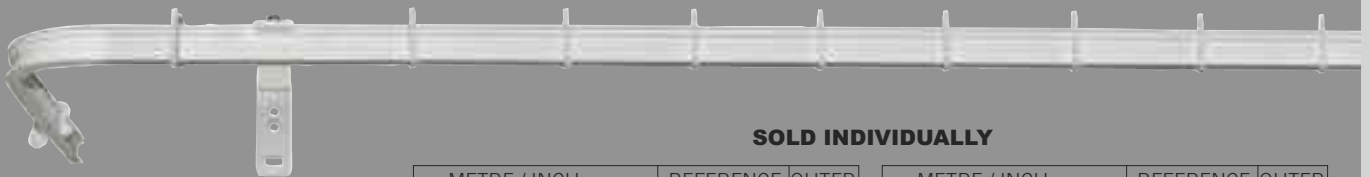

SOLD INDIVIDUALLY

METRE / INCH	REFERENCE	OUTER
1.50 m. / 59" (3 BKTS.)	7316062	6
2.00 m. / 79" (4 BKTS.)	7317062	6
2.50 m. / 98" (5 BKTS.)	7318062	6

METRE / INCH	REFERENCE	OUTER
3.00 m./2x59" (6 BKTS.)	7319062	6
3.50 m./2x69" (8 BKTS./2 PCS.)	7396062	6
4.00 m./2x79" (8 BKTS./2PCS.)	7400062	6

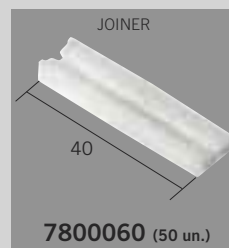

COLOUR CODE: 06. WHITE 40. SILVER

PACKAGING CODE: 0. BULK 2. BLISTER

<< PROFILE 900 >>

BENDING SERVICE AVAILABLE ON REQUEST

Sided Bay Window:
Type 11

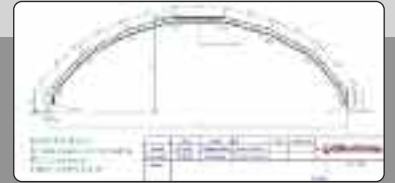
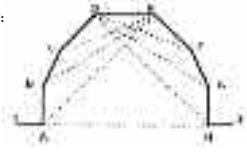

<p>1084060 (4 m.) 1083060 (3 m.)</p>	<p>7298060 (50 un.)</p>	<p>7397060 (50 un.)</p>	<p>7430060 (10 un.)</p>	<p>0958060 (50 un.)</p>	<p>0905060 (50 un.)</p>	
<p>0185060 (25 un.)</p>	<p>0652060 (50 un.)</p>	<p>0258060 (25 un.)</p>	<p>0182060 (25 un.)</p>	<p>1072060 (40x10 un.)</p>	<p>0689060 (40x10 un.)</p>	<p>2556060 (200 m.)</p>
<p>0901060 (50 un.)</p>	<p>0818060 (50 un.)</p>	<p>0902060 (50 un.)</p>	<p>0819060 (50 un.)</p>	<p>0903060 (50 un.)</p>	<p>0960060 (50 un.)</p>	
<p>1895060 (W) (20 un.) 1895400 (S) (20 un.)</p>	<p>7199060 (50 un.)</p>	<p>7229060 (50 un.)</p>	<p>7226060 (25 un.)</p>	<p>7230060 (25 un.)</p>	<p>7231060 (25 un.)</p>	
<p>0419060 (25 un.)</p>	<p>1224060 (10 un.)</p>	<p>1237060 (25 un.)</p>	<p>0400060 (25 un.)</p>	<p>1564440 (100 un.)</p>	<p>1888060 (1 un.)</p>	<p>0904060 (50 un.)</p>
<p>0993060 (50 un.)</p>	<p>7275060 (25 un.)</p>	<p>7276060 (25 un.)</p>	<p>3900400 (10 un.)</p>	<p>0961060 (50 un.)</p>	<p>0955060 (50 un.)</p>	<p>1062060 (25 un.)</p>
<p>0665060 (10 un.)</p>	<p>0744060 (6 un.)</p>	<p>0437060 (25 un.)</p>	<p>0892060 (50 un.)</p>	<p>1886060 (100 un.)</p>	<p>0563310 (1 un.)</p>	<p>0513000 (9 fillers)</p>

COLOUR CODE: 06. WHITE 40. SILVER
PACKAGING CODE: 0. BULK

« ALUMINIUM TRACK PROFILE 7600 »



SOLD INDIVIDUALLY
 UNCOILED TOP-FIX BRACKET (POLYBAG)
 WITH STRIP OF RUNNERS WITH WHEELS 0689060

METRE / INCH	WHITE REFERENCE	GREY REFERENCE	OUTER
1.50 m. / 59" (3 BKTS.)	7479064	7479324	10
2.00 m. / 79" (3 BKTS.)	7480064	7480324	10
2.50 m. / 98" (4 BKTS.)	7481064	7481324	10
3.00 m. / 118" (4 BKTS.)	7482064	7482324	10
3.50 m. / 138" (4 BKTS.)	7483064	7483324	10
4.00 m. / 157" (5 BKTS.)	7484064	7484324	10



SOLD INDIVIDUALLY
 UNCOILED TOP-FIX BRACKET (POLYBAG)
 WITH ROTATING EYE RUNNER 8075060

METRE / INCH	WHITE REFERENCE	GREY REFERENCE	OUTER
1.50 m. / 59" (3 BKTS.)	7485064	7485324	10
2.00 m. / 79" (3 BKTS.)	7486064	7486324	10
2.50 m. / 98" (4 BKTS.)	7487064	7487324	10
3.00 m. / 118" (4 BKTS.)	7488064	7488324	10
3.50 m. / 138" (4 BKTS.)	7489064	7489324	10
4.00 m. / 157" (5 BKTS.)	7490064	7490324	10



PROF 7600
(10 un.)

7603**0 (4 m.)

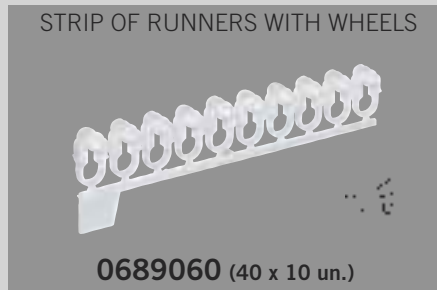

STRIP OF RUNNERS WITH WHEELS

0689060 (40 x 10 un.)



ROTATING EYE RUNNER

30

8075060 (100 un.)



TOP-FIX BRACKET

46

0252**0 (25 un.)

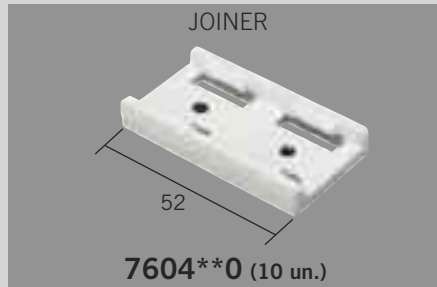

JOINER

52

7604**0 (10 un.)



END-CAP

25

7605**0 (50 un.)

** COLOUR CODE: 06. WHITE 32. GREY

« PROFILE 1076 »

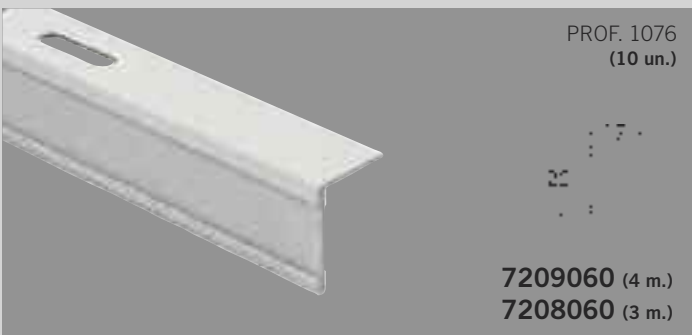

PROF. 1076
(10 un.)

7209060 (4 m.)
7208060 (3 m.)

« PROFILE 7198 »

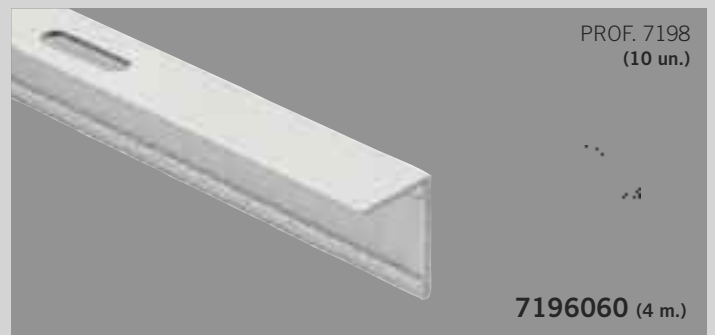

PROF. 7198
(10 un.)

7196060 (4 m.)

COLOUR CODE: 06. WHITE
 PACKAGING CODE: 0. BULK

« ALUMINIUM VALANCE PROFILE 909 WITH HOOK TAPE »



SOLD INDIVIDUALLY

METRE / INCH	REFERENCE	OUTER
1.50 m. / 59"	7253404	6
2.00 m. / 79"	7254404	6
2.50 m. / 98"	7255404	6
3.00 m. / 118"	7256404	6
3.50 m. / 138"	7258404	6
4.00 m. / 157"	7325404	6



PROFILE WITH HOOK TAPE. IDEAL FOR NETS.

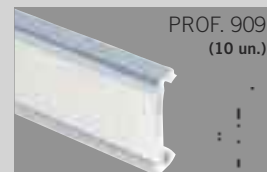

PROF. 909
(10 un.)

1090400 (4 m.)
1089400 (3 m.)



END-CAP

24,5

0801060 (50 un.)



TOP-FIX BKT.

26

0990060 (50 un.)



FACE/TOP-FIX BKT.

27

0800060 (50 un.)



CORNER ACC.

24,5

1060060 (25 un.)



JOINER

80

0824060 (25 un.)



LOOP SEW-ON TAPE
EASY-RELEASE

0991060 (25 m.)

« ALUMINIUM TRACK PROFILE 7244 » (T.B.D.)



SOLD INDIVIDUALLY

UNCORDED FACE-FIX TRACK

METRE / INCH	REFERENCE	OUTER
1.50 m. / 59"	7331063	4
2.00 m. / 79"	7332063	4
2.50 m. / 98"	7333063	4
3.00 m. / 118"	7334063	4
3.50 m. / 138"	7335063	4



SOLD INDIVIDUALLY

UNCORDED TOP-FIX TRACK

METRE / INCH	REFERENCE	OUTER
1.50 m. / 59"	7326063	4
2.00 m. / 79"	7327063	4
2.50 m. / 98"	7328063	4
3.00 m. / 118"	7329063	4
3.50 m. / 138"	7330063	4



PROF. 7244 (T.B.D.)
(10 un.)

7243060 (4 m.)



END-STOP

26

7236060 (50 un.)



SLIDE

31

0080060 (500 un.)



TOP-FIX SLIDE

17

0128060 (500 un.)

COLOUR CODE: 06. WHITE 40. SILVER

PACKAGING CODE: 0. BULK 3. SKIN 4. PLASTIC BAG

« WARDROBE-RODS »

OVAL TUBE



KITS SOLD INDIVIDUALLY

METRE / INCH	REFERENCE	OUTER
1.00 m. / 39"	2909**3	4
1.50 m. / 59"	2910**3	4
2.00 m. / 79"	2911**3	4

TUBE Ø16



KITS SOLD INDIVIDUALLY

METRE / INCH	REFERENCE	OUTER
1.00 m. / 39"	2991**3	4
1.50 m. / 59"	2992**3	4
2.00 m. / 79"	2993**3	4

** COLOUR: 06. WHITE 43. CHROMED 44. GOLD

« SHOWER-RODS »

EXTENDIBLE STRAIGHT SHOWER ROD Ø18



SOLD INDIVIDUALLY

METRE / INCH	REFERENCE	OUTER
0.74 - 1.24 m. / 29" - 49"	0006**2	20
1.23 - 2.16 m. / 48" - 85"	0007**2	20

** COLOUR: 06. WHITE 28. NAVY 29. PINK 40. SILVER 44. GOLD

CURVED SHOWER ROD Ø18



SOLD INDIVIDUALLY

METRE / INCH	REFERENCE	OUTER
80x80 to 122 cm. / 31"x31" to 48"	2558**3	10
80x110 to 196 cm. / 31"x39" to 77"	2559**3	10

** COLOUR: 06. WHITE 28. NAVY 29. PINK 40. SILVER 44. GOLD

« SHOWER-RODS ACCESSORIES »

SHOWER RING



55

0071060 (100 un.)

"PEAR" SHOWER RING



52

0147060 (100 un.)

CURVED SHOWER BRACKET
WHITE & SILVER



62

00774 (50 un.)**

COLOUR: 06. WHITE

COLOUR CODE: Where "**", substitute them with the required & available two digit colour code.

PACKAGING CODE: 0. BULK 2. BLISTER 3. SKIN 4. PLASTIC BAG