

CONTRACT TRACKS

MOTORISED TRACKS AND
ROLLER BLINDS

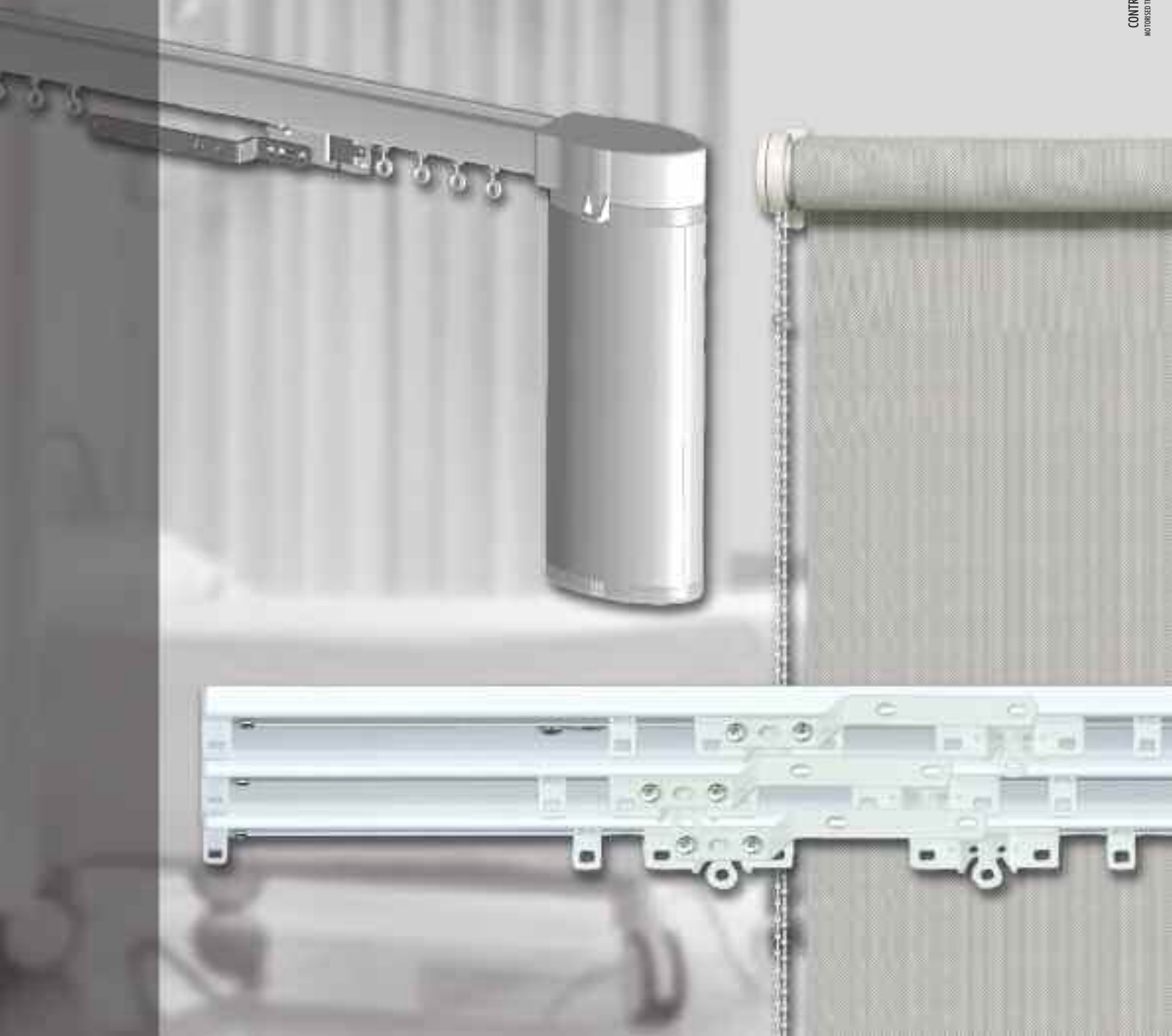

« ALUMINIUM TRACK & VALANCE PROFILE 1078 »

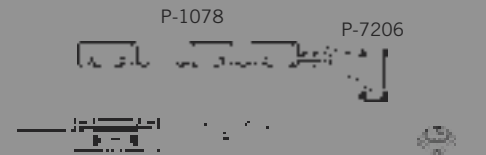
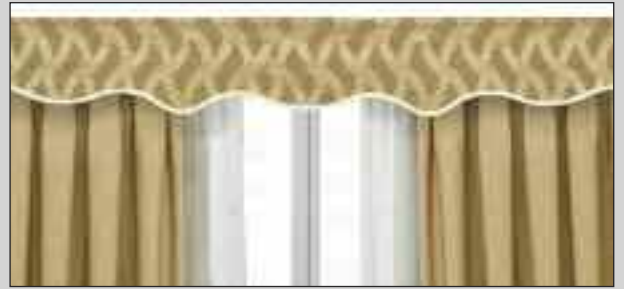

METRE / INCH	REFERENCE	OUTER
1.50 m. / 59"	7279064	1
2.00 m. / 79"	7321064	1
2.50 m. / 98"	7322064	1
3.00 m. / 118"	7323064	1
3.50 m. / 138"	7324064	1

KITS SUPPLIED WITH SCREWS AND WALL-PLUGS FOR TOP-FIXING



PROF. 1078
(10 un.)

7202060 (4 m.)
7201060 (3 m.)



END-STOPS/LEFT & RIGHT
(12 pairs)

1080060 (12 pairs)



CONNECTOR
20

1081060 (25 un.)

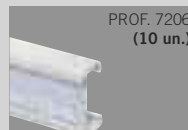

PROF. 7206
(10 un.)

7205060 (4 m.)
7204060 (3 m.)



END-CAP
22

1521060 (50 un.)



CEILING-WALL CORNER
22

7210060 (25 un.)



STOPPER
10,5

0917400 (100 un.)

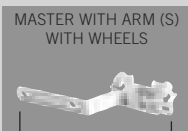

MASTER WITH ARM (S)
WITH WHEELS
82

0851060 (50 un.)



MASTER NO ARM
31

0953060 (50 un.)



PLAIN MASTER
WITH ARM (S)
82

0856060 (50 un.)



PLAIN MASTER NO ARM
46

0962060 (50 un.)

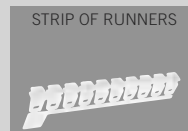

STRIP OF RUNNERS
1072060 (40x10 un.)

1072060 (40x10 un.)



STRIP OF RUNNERS
WITH WHEELS
0689060 (40x10 un.)

0689060 (40x10 un.)

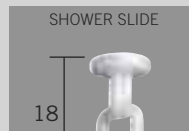

SHOWER SLIDE
18

1201060 (500 un.)

« ALUMINIUM VALANCE PROF. 909 WITH HOOK TAPE »

KITS SOLD INDIVIDUALLY

METRE / INCH	REFERENCE	OUTER
1.50 m. / 59"	7253404	6
2.00 m. / 79"	7254404	6
2.50 m. / 98"	7255404	6
3.00 m. / 118"	7256404	6
3.50 m. / 138"	7258404	6
4.00 m. / 157"	7325404	6



COLOUR CODE: 06. WHITE 40. SILVER
PACKAGING CODE: 0. BULK 4. PLASTIC BAG

« PROFILE 1129 »



P-1129



KITS SOLD INDIVIDUALLY

METRE / INCH	REFERENCE	OUTER
1.50 m. / 59"	7151064	4
2.00 m. / 79"	7152064	4
2.50 m. / 98"	7153064	4
3.00 m. / 118"	7154064	4
3.50 m. / 138"	7155064	4

KITS SUPPLIED WITH SCREWS AND WALL-PLUGS FOR TOP-FIXING

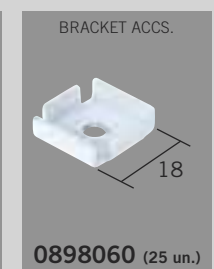
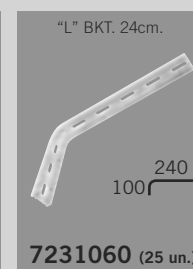
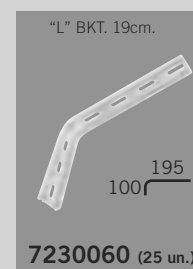
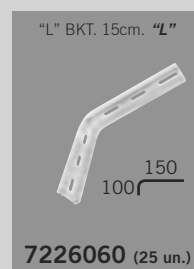
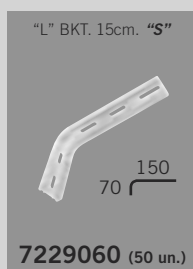
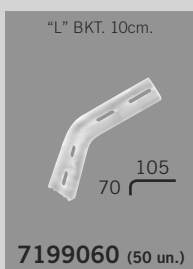
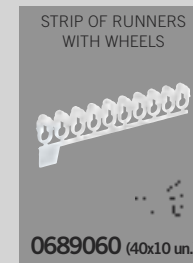
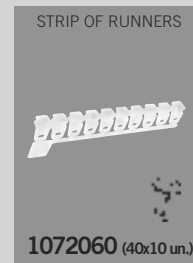
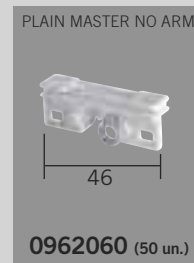
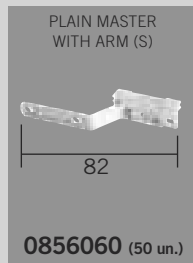
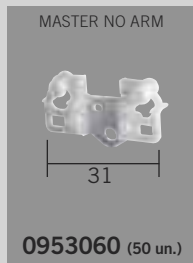
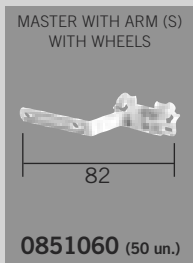
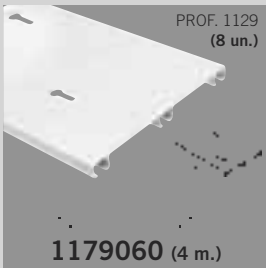

COLOUR CODE: 06. WHITE 40. SILVER

PACKAGING CODE: 0. BULK 4. PLASTIC BAG

« PROFILE 7269 »



P-7269



KITS SOLD INDIVIDUALLY

METRE / INCH	REFERENCE	OUTER
1.50 m. / 59"	7161064	4
2.00 m. / 79"	7162064	4
2.50 m. / 98"	7163064	4
3.00 m. / 118"	7164064	4
3.50 m. / 138"	7165064	4

KITS SUPPLIED WITH SCREWS AND WALL-PLUGS FOR TOP-FIXING

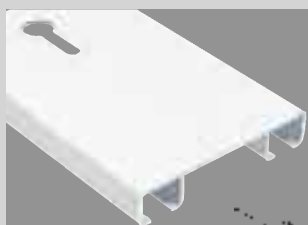

PROF. 7269
(12 un.)

7302060 (4 m.)
7303060 (3 m.)
7304060 (2 m.)

END-STOP



7301060 (50 un.)

MIDDLE-STOP



0892060 (50 un.)

STOPPER

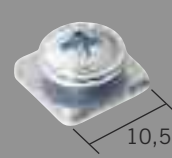

0917400 (100 un.)

MASTER WITH ARM (S)
WITH WHEELS



0851060 (50 un.)

MASTER NO ARM



0953060 (50 un.)

PLAIN MASTER
WITH ARM (S)



0856060 (50 un.)

PLAIN MASTER NO ARM

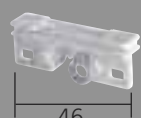

0962060 (50 un.)

STRIP OF RUNNERS



1072060 (40x10 un.)

STRIP OF RUNNERS
WITH WHEELS

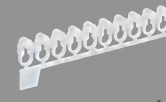

0689060 (40x10 un.)

SHOWER SLIDE



1201060 (500 un.)

"T" BKT.



1895060 (W) (20 un.)
1895400 (S) (20 un.)

"L" BKT. 10cm.



7199060 (50 un.)

"L" BKT. 15cm. "S"

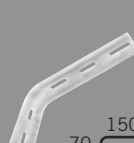

7229060 (50 un.)

"L" BKT. 15cm. "L"

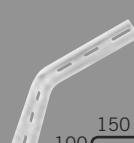

7226060 (25 un.)

"L" BKT. 19cm.



7230060 (25 un.)

"L" BKT. 24cm.

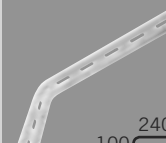

7231060 (25 un.)

BRACKET ACCS.

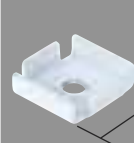

0898060 (25 un.)

COLOUR CODE: 06. WHITE 40. SILVER

PACKAGING CODE: 0. BULK 4. PLASTIC BAG

« PROFILE 7288 »



KITS SUPPLIED WITH SCREWS AND WALL-PLUGS FOR TOP-FIXING

P-7288

KITS SOLD INDIVIDUALLY

METRE / INCH	REFERENCE	OUTER
1.50 m. / 59"	7260064	4
2.00 m. / 79"	7261064	4
2.50 m. / 98"	7262064	4
3.00 m. / 118"	7267064	4
3.50 m. / 138"	7268064	4

PROF. 7288
(12 un.)

7289060 (4 m.)
7290060 (3 m.)
7291060 (2 m.)

END-STOP

7292060 (50 un.)

END-STOP

7301060 (50 un.)

MIDDLE-STOP

0892060 (50 un.)

PLASTIC STOPPER

7293060 (50 un.)

MASTER WITH ARM (S)
WITH WHEELS

0851060 (50 un.)

MASTER NO ARM

0953060 (50 un.)

PLAIN MASTER
WITH ARM (S)

0856060 (50 un.)

PLAIN MASTER NO ARM

0962060 (50 un.)

STRIP OF RUNNERS

1072060 (40x10 un.)

STRIP OF RUNNERS
WITH WHEELS

0689060 (40x10 un.)

SHOWER SLIDE

1201060 (500 un.)

"T" BKT.

1895060 (W) (20 un.)
1895400 (S) (20 un.)

"L" BKT. 10cm.

7199060 (50 un.)

"L" BKT. 15cm. "S"

7229060 (50 un.)

"L" BKT. 15cm. "L"

7226060 (25 un.)

"L" BKT. 19cm.

7230060 (25 un.)

"L" BKT. 24cm.

7231060 (25 un.)



BRACKET ACCS.





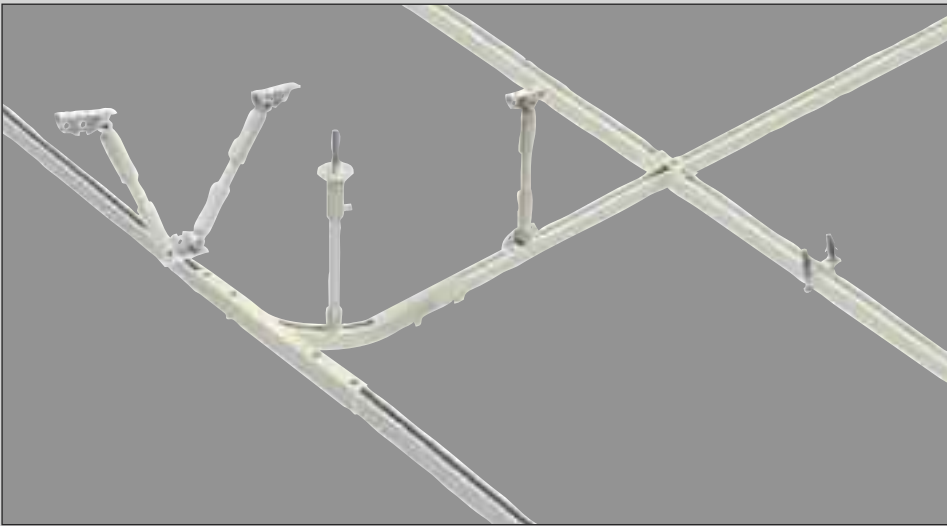

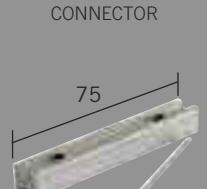
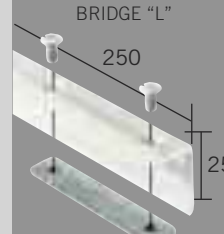
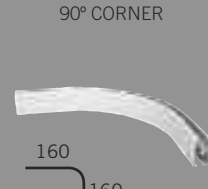
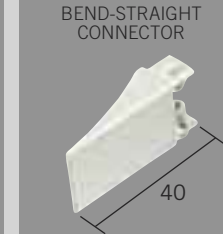
0898060 (25 un.)

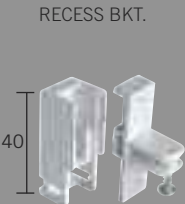

COLOUR CODE: 06. WHITE 40. SILVER
PACKAGING CODE: 0. BULK 4. PLASTIC BAG

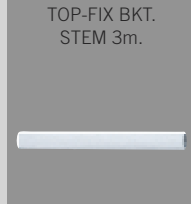
« ROOM DIVIDER SYSTEM PROFILE 908 »

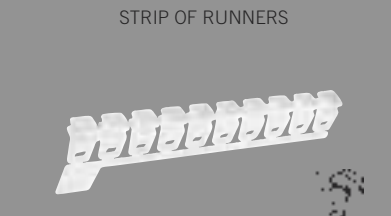
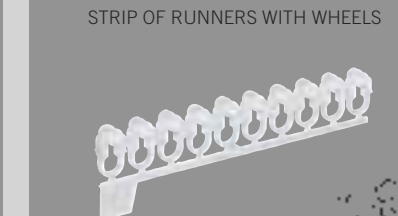

 <p>PROF. 908 (10 un.)</p> <p>1087060 (4 m.) 1086060 (3 m.)</p>	 <p>CONNECTOR</p> <p>75</p> <p>7320400 (12 un.)</p>	 <p>BRIDGE "L"</p> <p>250</p> <p>25</p> <p>7305060 (10 un.)</p>	 <p>90° CORNER</p> <p>160</p> <p>160</p> <p>7310060 (12 un.)</p>	 <p>BEND-STRAIGHT CONNECTOR</p> <p>40</p> <p>7309060 (25 un.)</p>	 <p>PLASTIC DUSTCOVER</p> <p>11</p> <p>7306060 (10 m.)</p>
--	--	--	--	--	---

 <p>RECESS BKT.</p> <p>40</p> <p>0955060 (50 un.)</p>	 <p>TOP-FIX BKT. TOP & BOTTOM FIX</p> <p>45</p> <p>30</p> <p>0655060 (10 un.)</p>	 <p>TOP-FIX BKT. TOP & BOTTOM FIX</p> <p>65</p> <p>0744060 (6 un.)</p>	 <p>TOP-FIX BKT. STEM 3m.</p> <p>0437060 (25 un.)</p>	 <p>TOP-FIX BKT.</p> <p>44</p> <p>7308060 (25 un.)</p>	 <p>CONNECTOR IN CROSS</p> <p>44</p> <p>7307060 (25 un.)</p>	 <p>PLASTER-CEILING BKT.</p> <p>62</p> <p>0934400 (25 un.)</p>
--	---	--	---	---	--	--

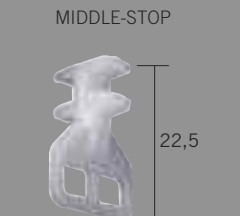
 <p>STRIP OF RUNNERS</p> <p>1072060 (40 x 10 un.)</p>	 <p>STRIP OF RUNNERS WITH WHEELS</p> <p>0689060 (40 x 10 un.)</p>	 <p>SHOWER SLIDE</p> <p>18</p> <p>1201060 (500 un.)</p>	 <p>MIDDLE-STOP</p> <p>22,5</p> <p>0892060 (50 un.)</p>
---	--	---	--

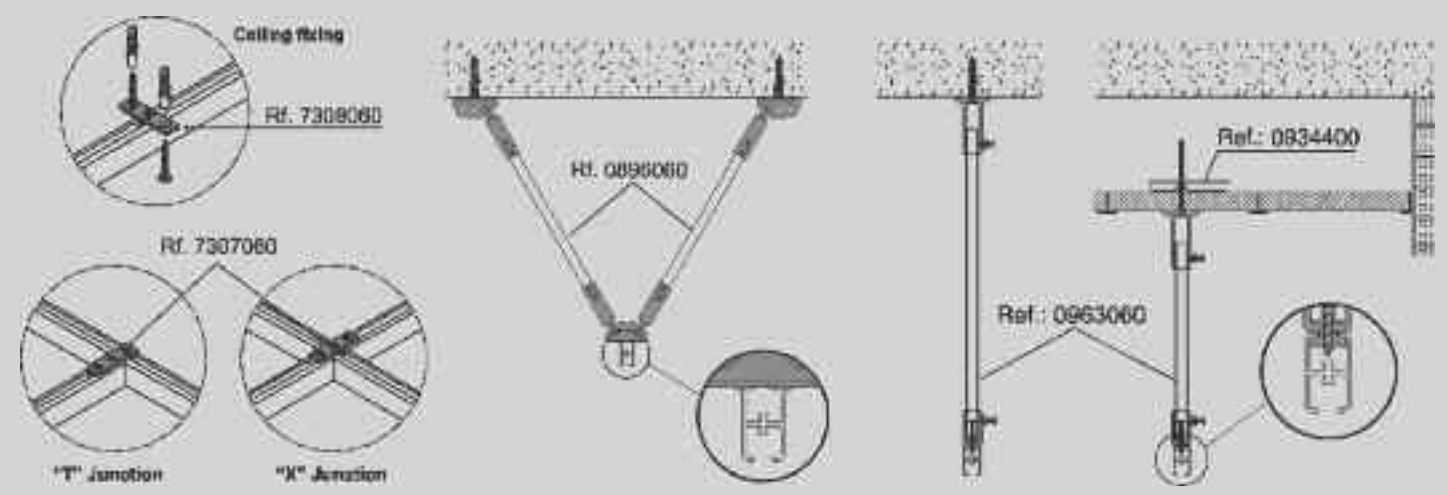

COLOUR CODE: 06. WHITE 40. SILVER

PACKAGING CODE: 0. BULK

« PROFESSIONAL TRACK »

PROFILE 7700 - MADE TO MEASURE

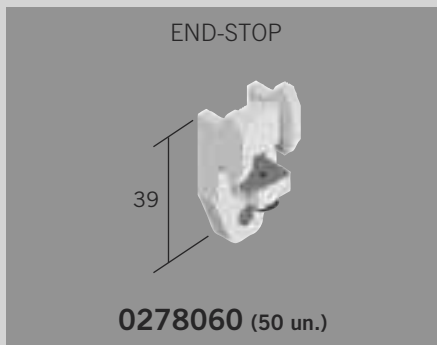
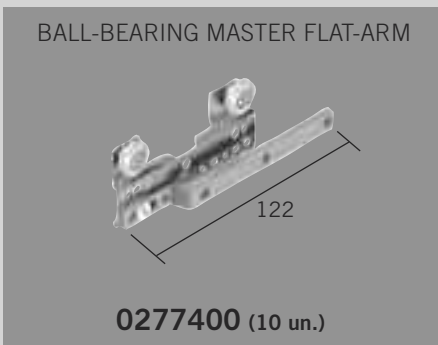
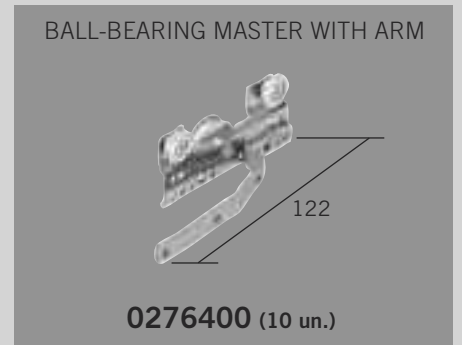
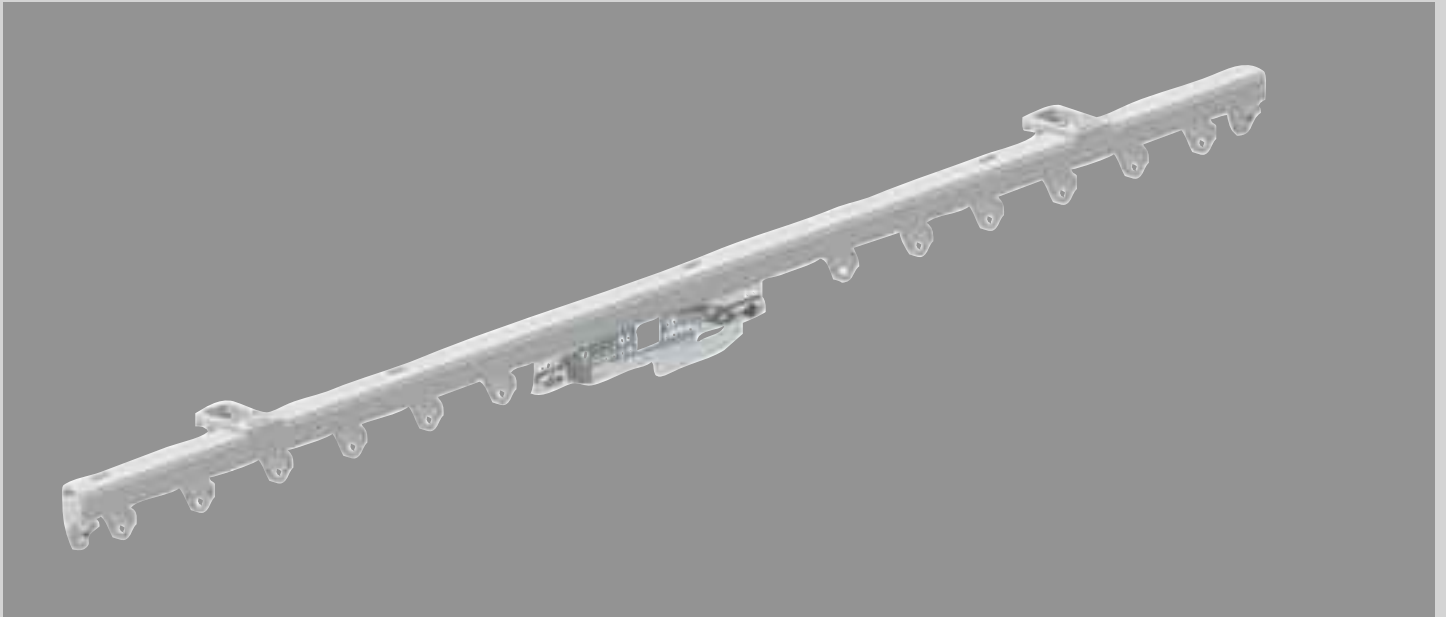

« MOTORISED TRACKS »

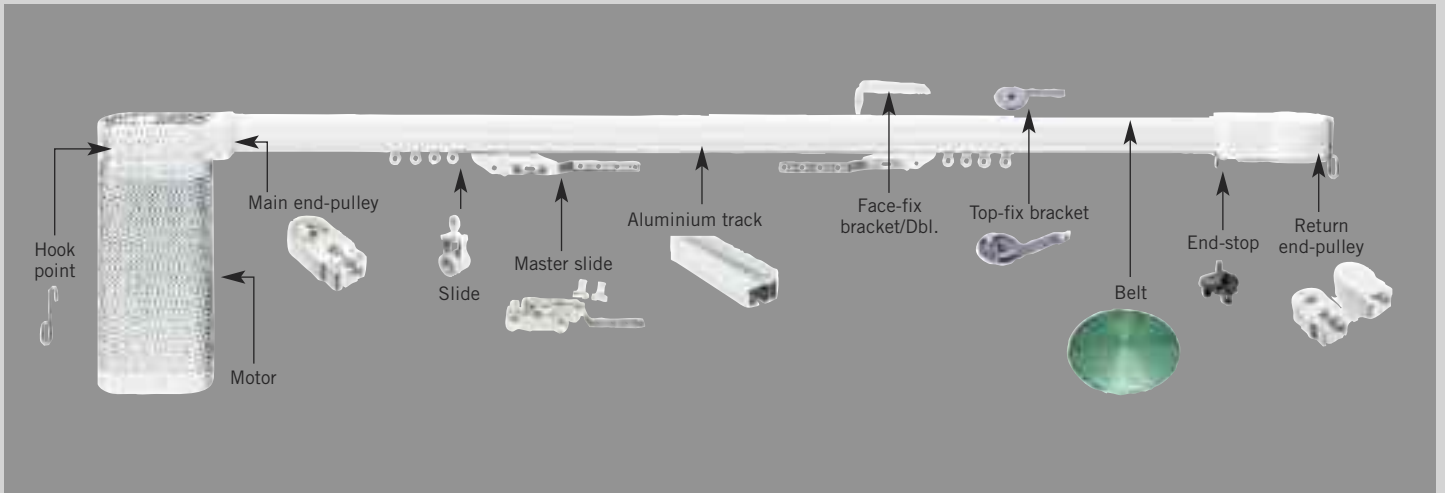

« BESPOKE MADE-TO-MEASURE ROLLER BLINDS »

