

CURTAIN TAPES EYELETS & HOOKS

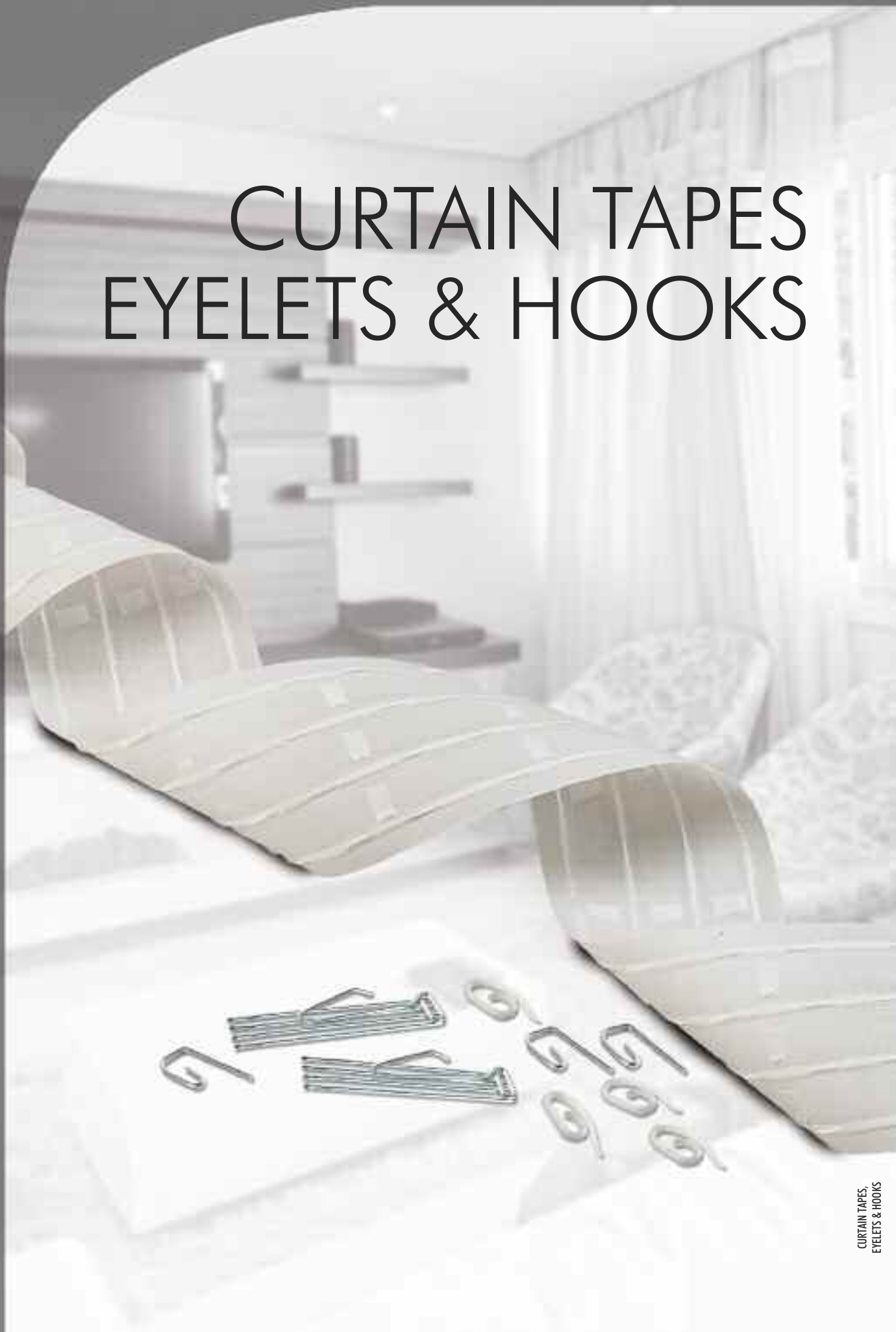

<< PENCIL PLEAT TAPES (AUTOMATIC) >>

F-AUTOMATIC 30 (W. & B. 1 POCKET / 2 STRINGS - RAPPORT 2 X 1)

Rf. 0261**1 (100 m.)



F-AUTOMATIC 55 (W. & B. 2 POCKETS / 2 STRINGS - RAPPORT 2 X 1)

Rf. 0550**1 (100 m.)



F-AUTOMATIC 65D (W., B. & CL. 2 POCKETS / 2 STRINGS - RAPPORT 2 X 1)

Rf. 0220**1 (100 m.)



F-AUTOMATIC 70/5 (W. & B. 5 POCKETS / 2 STRINGS - RAPPORT 2 X 1)

Rf. 1661**1 (100 m.)

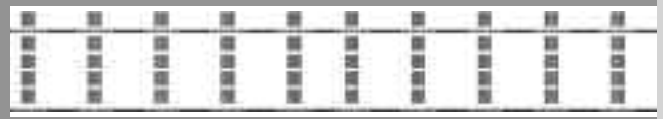

F-AUTOMATIC 75/5 LUXE (W. & B. 5 POCKETS / 3 STRINGS - RAPPORT 2 X 1)

Rf. 0524**1 (100 m.)

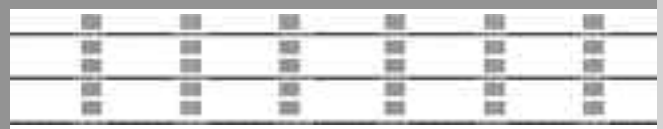

F-AUTOMATIC 75/6 INV. (CL. 6 POCKETS / 2 STRINGS - RAPPORT 2 X 1)

Rf. 0216201 (100 m.)

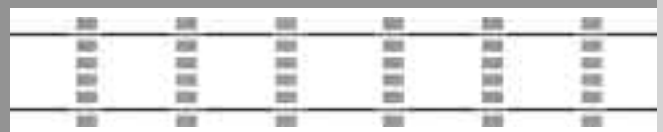
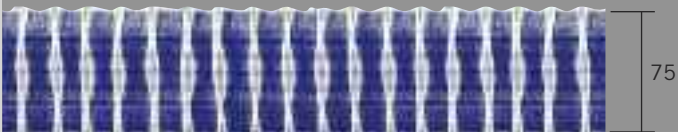

F-AUTOMATIC 85 (W. & B. 3 POCKETS / 3 STRINGS - RAPPORT 2 X 1)

Rf. 0222**1 (100 m.)



MULTIFUNCTION 100 ROD (CL. 1 POCKET / 3 STRINGS - RAPPORT 2 X 1)

Rf. 0218201 (100 m.)



COLOUR CODE: Where "**", substitute them with the required & available two digit colour code: 06. WHITE 20. CLEAR 21. BEIGE

PACKAGING CODE: 1. BOX

« PENCIL PLEAT TAPES (AUTOMATIC) »

F-AUTOMATIC 120/5 (W. 5 POCKETS / 4 STRINGS - RAPPORT 2 X 1)

Rf. 0527061 (100 m.)

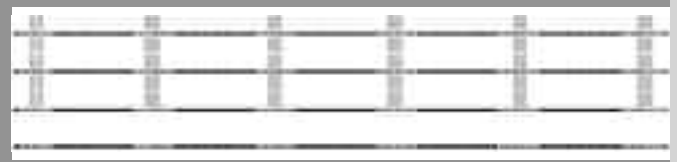

F-AUTOMATIC 120/7 (CL. 7 POCKETS / 4 STRINGS - RAPPORT 2 X 1)

Rf. 0528201 (100 m.)

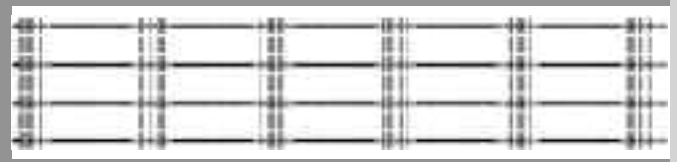

« PENCIL PLEAT TAPES (ADJUSTABLE) »

LIA 35 (W. & B. 1 POCKET / 2 STRINGS)

Rf. 0253**1 (100 m.)



LIA 55 (W. & B. 2 POCKETS / 4 STRINGS)

Rf. 0254**1 (100 m.)



LIA 75 (W. & B. 2 POCKETS / 4 STRINGS)

Rf. 0255**1 (100 m.)

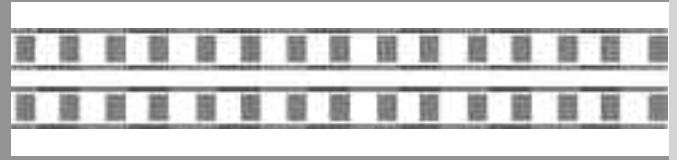

F-70/4 (CL. 4 POCKETS / 3 STRINGS)

Rf. 0055201 (100 m.)

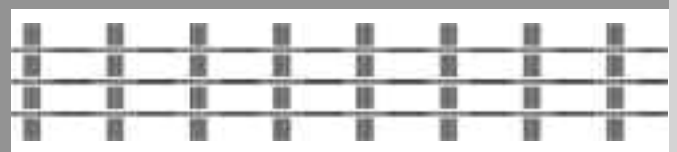
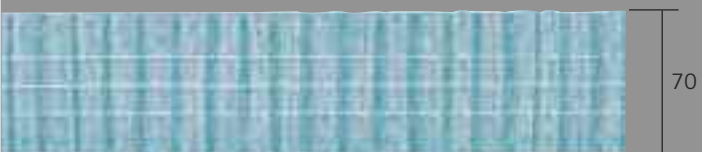

« PENCIL PLEAT TAPES (AUTOMATIC/LOOP) »

F-AUTOMATIC 40 LOOP (W. 2 STRINGS - RAPPORT 2 x 1)

Rf. 1656061 (100 m.)



F-AUTOMATIC 65 LOOP (W. 1 POCKET / 2 STRINGS - RAPPORT 2 x 1)

Rf. 1655061 (100 m.)



COLOUR CODE: Where "**", substitute them with the required & available two digit colour code: 06. WHITE 21. BEIGE

PACKAGING CODE: 1. BOX

« MULTI PLEAT TAPES (AUTOMATIC) »

E-AUTOMATIC 65 (W. & B. 2 POCKETS / 3 STRINGS - RAPPORT 2 X 1)

Rf. 0228**1 (100 m.)



E-AUTOMATIC 85 (W. & B. 2 POCKETS / 3 STRINGS - RAPPORT 2 X 1)

Rf. 0229**1 (100 m.)



TRIPLEC 75/3 (W. & B. 3 POCKETS / 3 STRINGS - RAPPORT 2 X 1)

Rf. 0179**1 (100 m.)

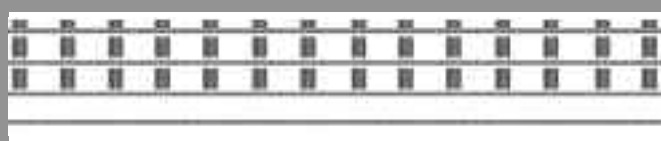

TRIPLEC 120/5 (W. & B. 5 POCKETS / 4 STRINGS - RAPPORT 2 X 1)

Rf. 0225**1 (100 m.)

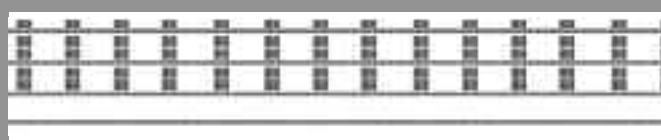

GOBLET 100 (W. & B. 4 POCKETS / 3 STRINGS - RAPPORT 2 X 1)

Rf. 0236**1 (100 m.)

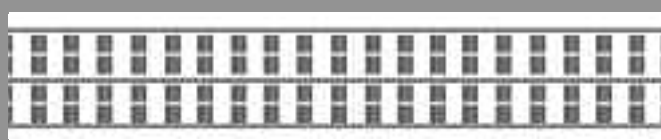

« BOX PLEAT TAPES »

PANELS 75/5-250 (W. & B. 5 POCKETS / 2 STRINGS - RAPPORT 2.5 X 1)

Rf. 0465**1 (100 m.)

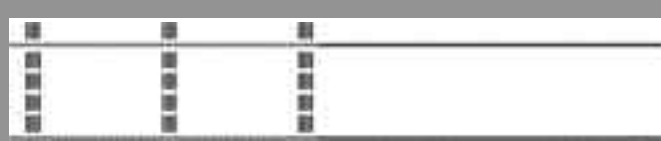

PANELS 75/5-200 (W. & B. 5 POCKETS / 2 STRINGS - RAPPORT 2 X 1)

Rf. 1651**1 (100 m.)

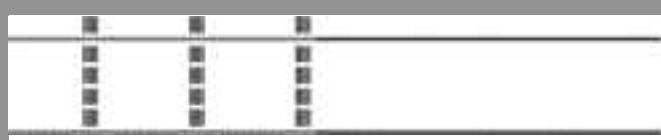

PANELS 75/6-200 (CL. 6 POCKETS / 2 STRINGS - RAPPORT 2 X 1)

Rf. 0219201 (100 m.)

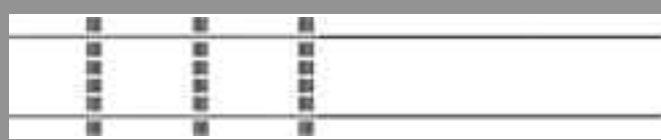

COLOUR CODE: Where ***, substitute them with the required & available two digit colour code: 06. WHITE 21. BEIGE

PACKAGING CODE: 1. BOX

« BOX PLEAT TAPES (LOOP) »

PANELS 40 LOOP (W. 2 STRINGS - RAPPORT 2.3 X 1)

Rf. 1654061 (100 m.)



PANELS 75-230 LOOP (W. 3 POCKETS / 2 STRINGS - RAPPORT 2.3 X 1)

Rf. 1653061 (100 m.)

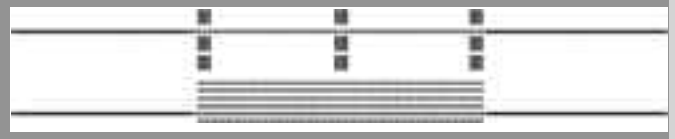

« SMOCK TAPES »

HEXANYL 85 (W. & B. 3 POCKETS / 4 STRINGS - RAPPORT 2.2 X 1)

Rf. 0234**1 (100 m.)

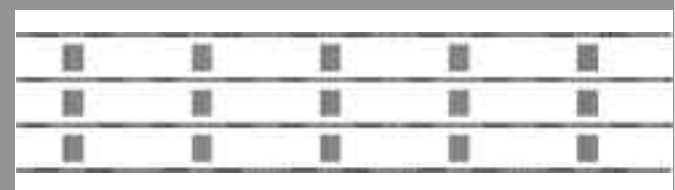

BEEHIVE 85 (W. & B. 3 POCKETS / 3 STRINGS - RAPPORT 2.2 X 1)

Rf. 0231**1 (100 m.)

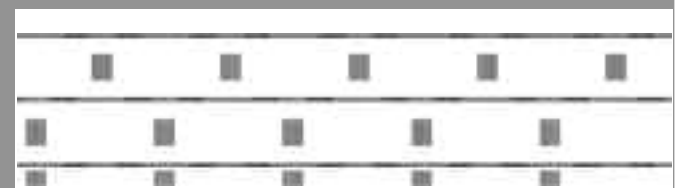

« CORTITEX TAPES »

CORTITEX 70/3 (3 POCKETS).
WHITE



Rf. 1663061 (100 m.)

CORTITEX 70/6 (6 POCKETS).
WHITE



Rf. 0158061 (100 m.)

CORTITEX 75/6 (6 POCKETS).
CLEAR



Rf. 0217201 (100 m.)

CORTITEX 75/2 (2 POCKETS).
CLEAR

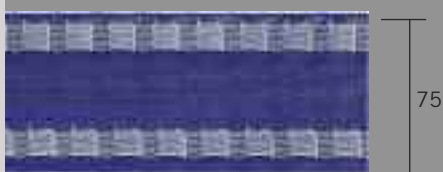

Rf. 0256201 (100 m.)

CORTITEX 75/2
(2 POCKETS). CLEAR



Rf. 0281201 (100 m.)

UNDULATOR. CLEAR



Rf. 0299000 (Bag of 100 units)

COLOUR CODE: Where ***, substitute them with the required & available two digit colour code: 06. WHITE 21. BEIGE

PACKAGING CODE: 1. BOX

« BLIND TAPES »

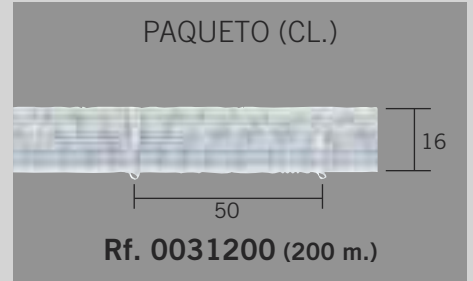
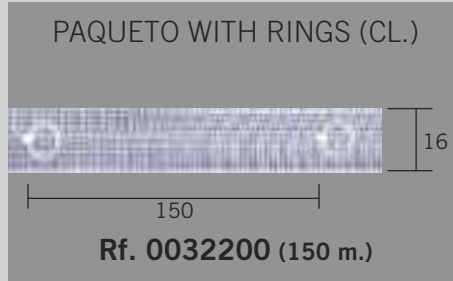
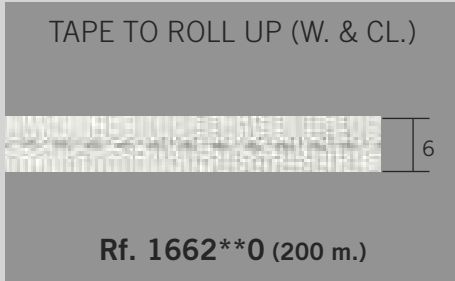

« LOOP & HOOK TAPES »

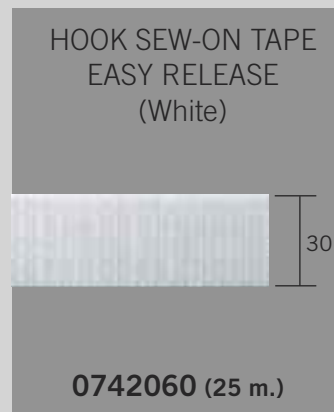
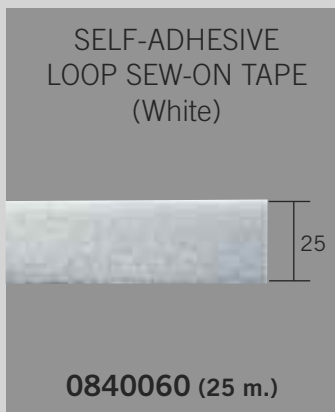
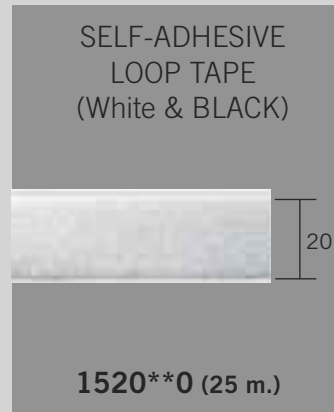
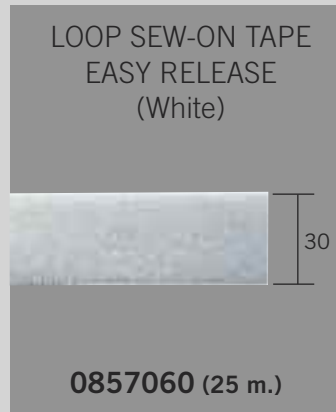

« LEADWEIGHT »

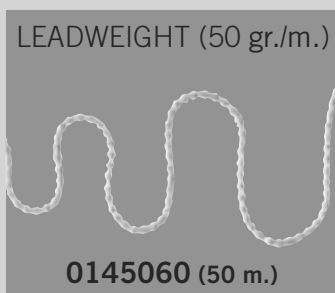

« DOUBLE-STICK »

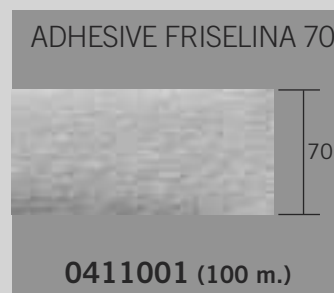

« BOOKLET »



COLOUR CODE: Where ***, substitute them with the required & available two digit colour code: 06. WHITE 20. CLEAR 21. BEIGE

PACKAGING CODE: 0. BULK 1. BOX

« REINFORCING TAPES »

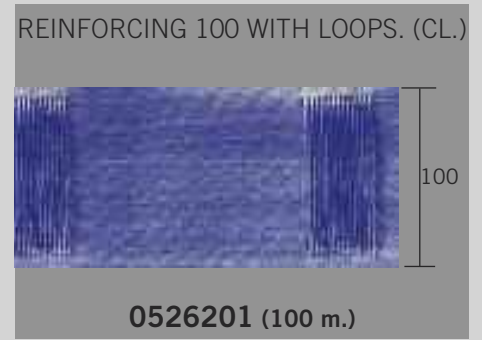
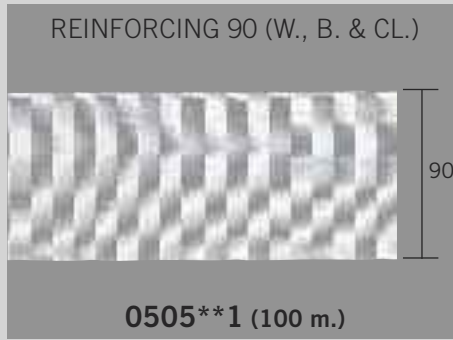
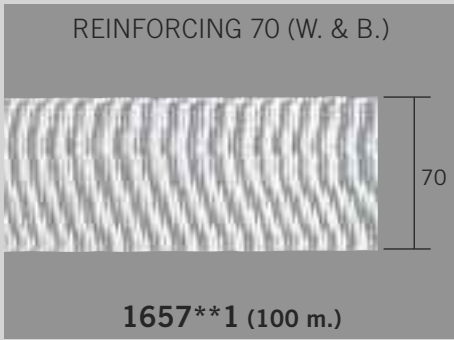

« CURTAIN EYELETS »



COLOURS: 20. CLEAR



** COLOURS: 41. ANTIQ. COPPER 42. MATT-NICKEL
47. ANTIQUE-BRASS 49. STAINLESS STEEL

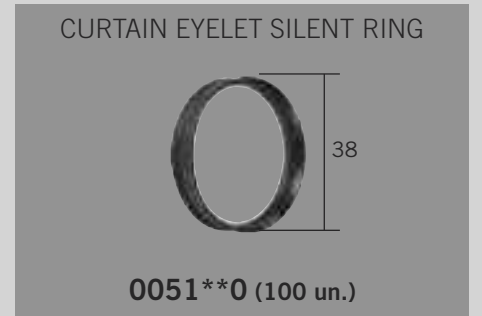

** COLOURS: 07. BLACK 20. CLEAR



**COLOURS: 43. CHROMED 47. ANTIQUE-BRASS



COLOURS: 42. MATT-NICKEL



COLOURS: 47. ANTIQUE-BRASS (TRANSPARENT)

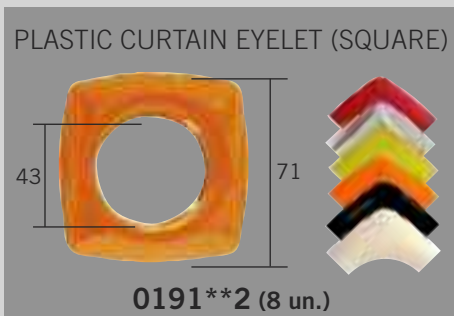

**COLOURS: 06. WHITE 07. BLACK 26. ORANGE
31. GREEN 43. CHROMED 83. FUCHSIA

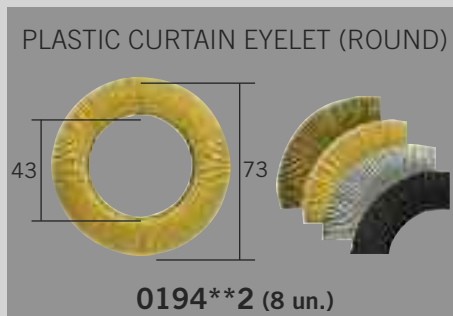

**COLOURS: 07. BLACK 32. GREY
44. GOLD 47. ANTIQUE-BRASS

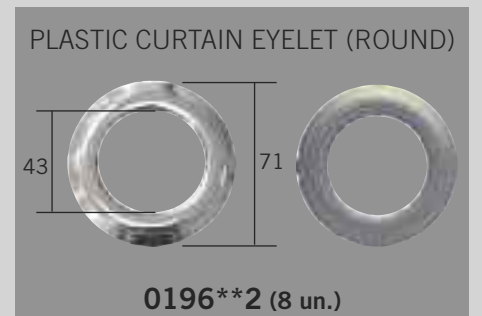

**COLOURS: 42. MATT-NICKEL 43. CHROMED

« EYELETS TAPES »



COLOUR CODE: Where "**", substitute them with the required & available two digit colour code.

PACKAGING CODE: 0. BULK 1. BOX 2. BLISTER

« DEEP PLEAT TAPES »

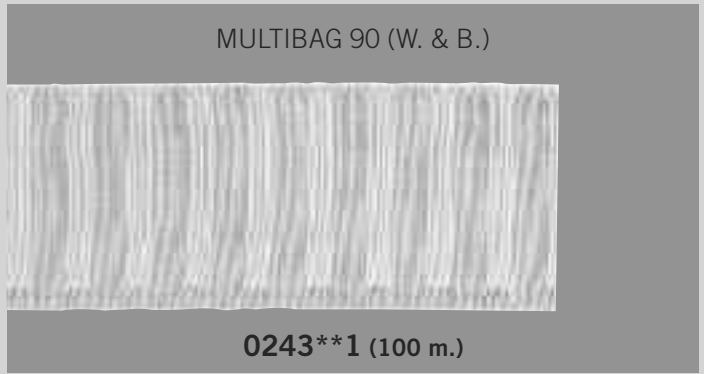

« MULTI-PRONGED CURTAIN HOOKS »

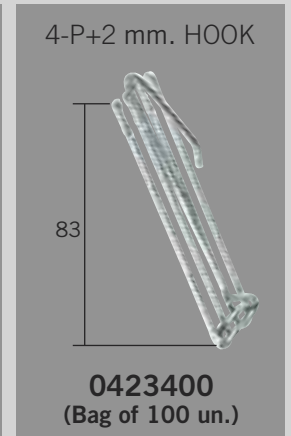
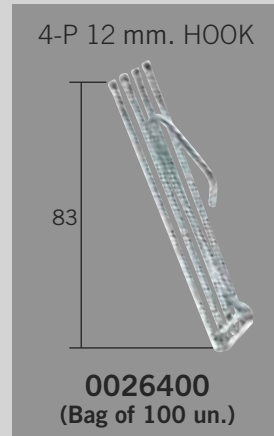
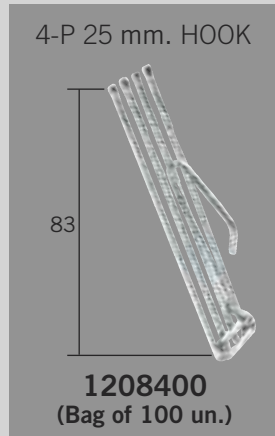
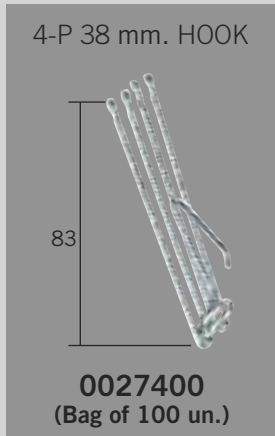
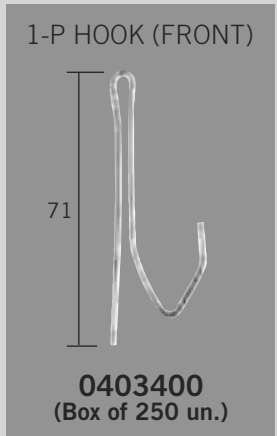

« CURTAIN HOOKS »

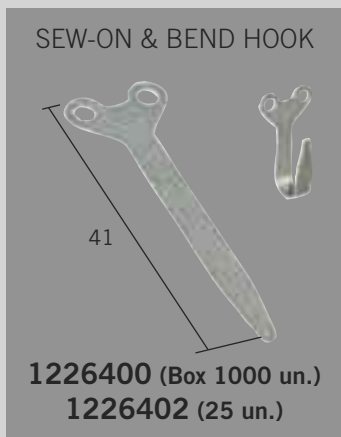
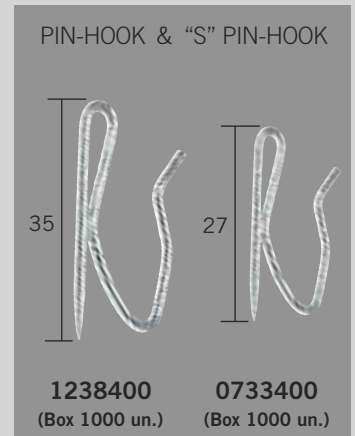
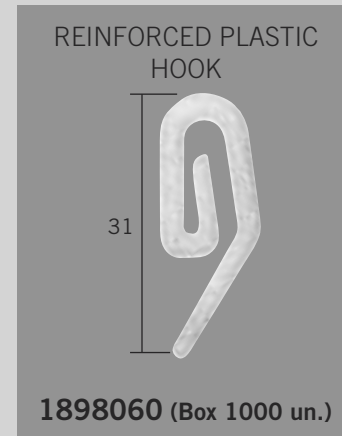

COLOUR CODE: Where "**", substitute them with the required & available two digit colour code: 06. WHITE 21. BEIGE

PACKAGING CODE: 0. BULK 1. BOX 2. BLISTER